

GMH-40 Tabletop Hinge

Features

- Double pivot hinge allows 180° opening
- Passed 10,000 life cycle test

Notes

- Recommended door dimensions in the below table are based on usage of two hinges for one door

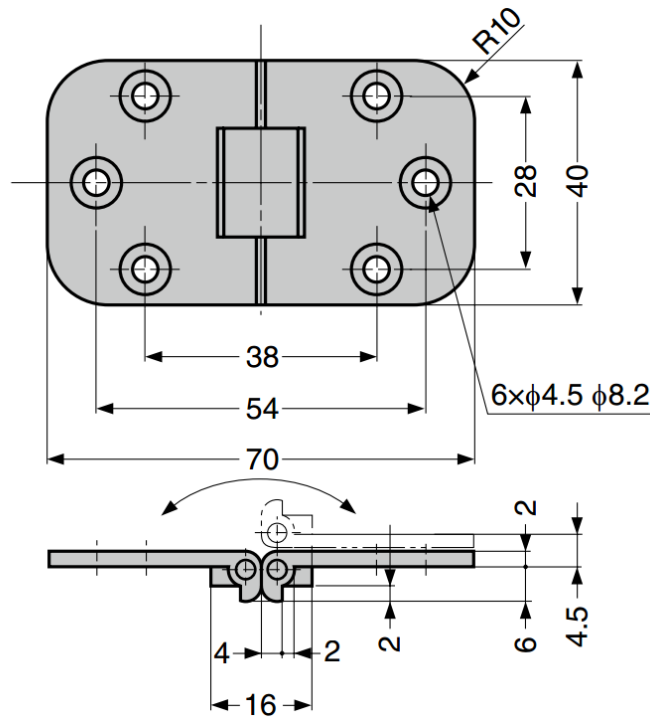
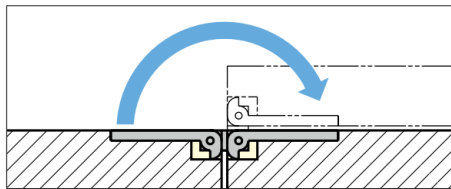
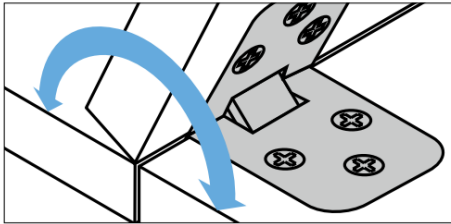

Part No.	Material	Finish	Door Width	Door Height	Door Thickness	Opening Angle	Load Capacity (per pair)	
GMH-40M	Brass	Polished	Max. 450	Max. 700	Max. 21	180°	29 N	3 kg
GMH-40WB		White Bronze Plating						
GMH-40CR		Chrome						